

Installation Instructions



www.nova-flo.com



IMV090119

Fig. 1
Part descriptions & Dimensions (mm)

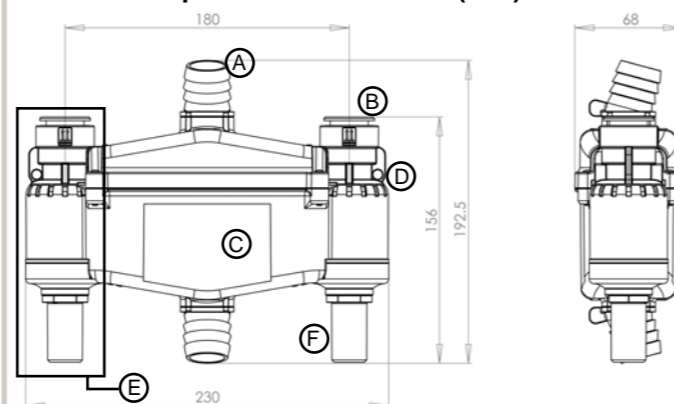

- A. Barb connector
- B. 22mm Push-fit pipe connector
- C. Main Body
- D. Securing Ear
- E. Side Valve
- F. 22mm Stub Connector

WARNINGS

Don't put fingers or other body parts into apertures or plumbing fittings on the unit! These can contain sharp edges.

Use a pipe cutter to cut any pipe. Do not use a hacksaw as this can leave a jagged and off-square cut which will damage the plumbing fittings upon insertion.

Do not use soldered or compression fittings or solder flux in direct contact with the unit.

Care must be taken to avoid any heat transfer to the unit if soldering fittings in close proximity.

Fig. 3
Typical installation

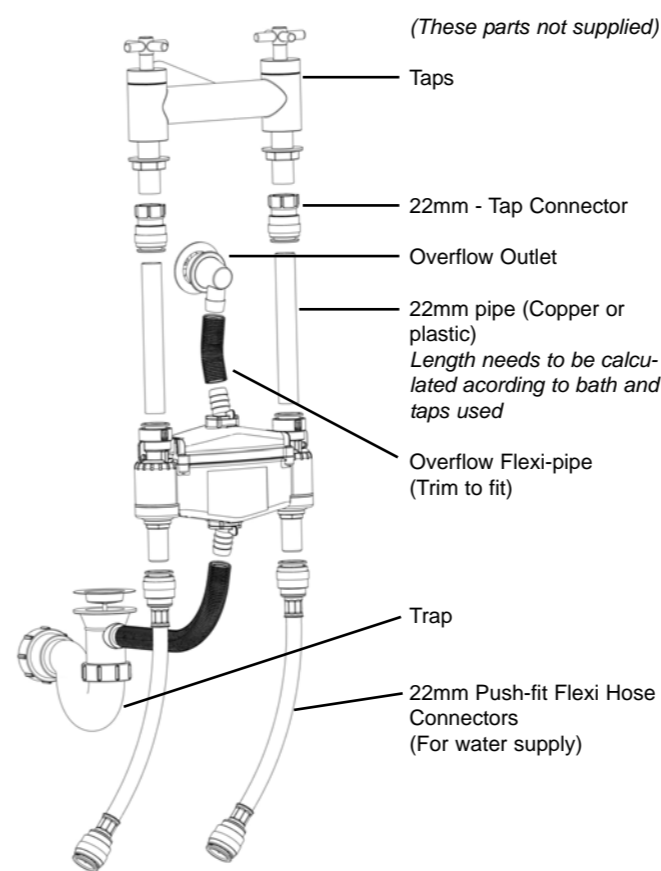

(These parts not supplied)

- Taps
- 22mm - Tap Connector
- Overflow Outlet
- 22mm pipe (Copper or plastic)
Length needs to be calculated according to bath and taps used
- Overflow Flexi-pipe (Trim to fit)
- Trap
- 22mm Push-fit Flexi Hose Connectors (For water supply)

Fig. 4
Bath Filler & Waste Combination

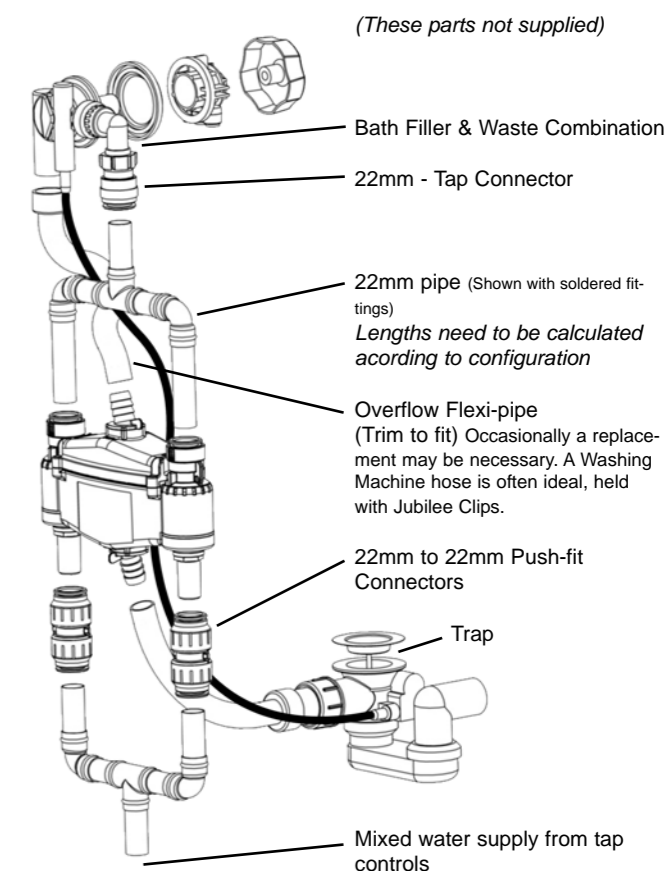

(These parts not supplied)

- Bath Filler & Waste Combination
- 22mm - Tap Connector
- 22mm pipe (Shown with soldered fittings)
Lengths need to be calculated according to configuration
- Overflow Flexi-pipe (Trim to fit) Occasionally a replacement may be necessary. A Washing Machine hose is often ideal, held with Jubilee Clips.
- 22mm to 22mm Push-fit Connectors
- Trap
- Mixed water supply from tap controls

Congratulations on purchasing a Nova-Flo™ anti flooding device





Fitted correctly, Nova-Flo™ will provide you and your family peace of mind and constant protection from an overflowing bath. Since the water will be substantially shut off once activated, the device will also save on wasted water and energy.

Recommendation

Baths, taps and overflows differ greatly and care must be taken to understand the individual plumbing arrangements prior to undertaking any installation.

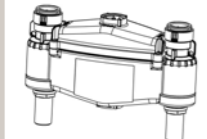
Ensure you can isolate the supply water and are familiar with work of this nature. We recommend you always use a qualified professional plumber to install a Nova-Flo™ unit.

Box contents

-  X 1 Nova-Flo™ Bath Unit
-  X 2 Large Barb Connector
-  X 2 Small Barb Connector
-  X 2 O-Ring for Barb Connectors
-  X 2 Rubber Sleeve

Orientation

The Nova-Flo™ unit must be fitted in a vertical orientation. It must not be fitted lying flat or crooked since this will hinder operation. Directions are clearly marked on the main body of the Nova-Flo™ unit.

Positioning

The Nova-Flo™ unit must be located between the overflow outlet (See Fig. 3) and the Trap in as high a position as can be achieved. Fixings such as cable ties, screws or flexible wire can be used through the ears (Fig.1, D) on the Nova-Flo™ unit to support it in the preferred position if needed.

This position will allow any excess water flowing through the overflow outlet in the bath to pass through the Nova-Flo™ unit causing activation of the valves to shut off the supply water.

The positioning of the Nova-Flo™ unit is the same for all types of installations.

Connection to overflow pipe

Nova-Flo™ will fit the majority of flexible overflow pipes found on common bath overflows. The existing overflow pipe will need to be cut to leave two lengths, so do take care to measure up carefully ensuring that there will be adequate pipe lengths leading to and from the Nova-Flo™ barb fittings.

The barb connector (Fig. 1, A) is attached to the Nova-Flo™ body by insertion and rotation of 45 degrees clockwise.

The four points on the barb fitting must line up with the point indicators on the Nova-Flo™ body and cap when fully secure.

The barb is set at an angle to aid off-centre installations. There are four positions to direct the barb fitting by inserting it in the desired position.

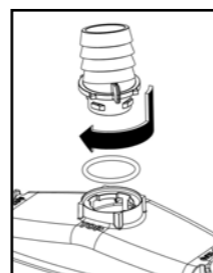

There are two sizes of overflow barb connectors supplied with Nova-Flo™ in order to fit the majority of flexible overflow pipes available. The overflow pipe should be pushed onto the barb connector firmly, creating a watertight fit.

For a tight fitting pipe, submerge the overflow pipe in boiling water to soften it enough to push over the barb connector. **Take care not to scald yourself!**

For a loose fitting pipe, use the supplied rubber sleeve to enlarge the barb connector. A small smear of silicone sealant on the outside of the sleeve will aid insertion into the pipe.

Please ensure all fittings are watertight by looking for leaks during testing once the installation is complete.

Water supplies

The Nova-Flo™ valves are not hot or cold specific, so hot or cold water can be run through either side.

1. Bath and Wall Mounted taps: (See Fig. 3)

The water supplies for the hot and cold feeds must pass up through each 22mm Stub Connector (Fig. 1, F) of the Nova-Flo™ unit respectively and the top 22mm Push-fit pipe connectors (Fig. 1, B) lead to the tap controls or mixer.

2. Bath Filler and Waste Combinations: (See Fig. 4)

The mixed water supply fed from the tap controls is to be split and directed equally to both 22mm Stub Connectors. The top 22mm Push-fit pipe connectors are then to be reconnected and a branch led to the Filler and Waste Head.

Use of a Thermostatic Mixing Valve (TMV)

It is recommended that a TMV be installed prior to the Nova-Flo™ unit. E.g. thermally mixed water should be directed through one side valve of the Nova-Flo™ unit. Nova-Flo™ is rated at a maximum hot water temperature of 60 degrees Centigrade.

Purging of system

The system, once fitted will need to be purged to clear any air inside the system. This is done by allowing the taps to flow at full rate for 1 minute, then turning them off. Repeat this procedure three times. Should the valves actuate, simply turn off the taps, wait for five seconds then turn them on gently. Once the system is purged of air, activation of the valves such as this will not occur. In some installations with an exceptionally fast flow rate, unexpected water shut off may occur before the bath is full. In this occurrence simply restrict the water flow by closing the supply valves slightly.

Testing

Test for leaks before replacing any bath surround or cladding.

To ensure correct operation of Nova-Flo™, you are advised to check its operation once every six months. To do this, use the water from a shower head or a large jug of water whilst the taps are running, pouring into the overflow outlet until activation. Whilst doing this it can be quicker to cup a cloth with your hand below the overflow outlet to channel more water into it.

Should the overflow system ever become clogged with soap, hair etc. In the event

of a blockage remove the lower barb connector by rotating it 45 degrees anti-clockwise and clear any debris with a cotton bud or similar, then replace the barb connector.

Resetting the water upon activation of the valves

If water pours down the overflow outlet, the taps will stop running at full flow and will be substantially shut off. There will remain a small trickle of water which is intentional and reminds the user to turn off the taps (The overflow can easily handle this trickle). To reset the unit, ensure there is no more water going through the overflow then simply turn off the taps and wait for five seconds. Upon turning them on again, full flow is resumed.

Your taps and water supply will be unaffected in normal use.

Recommended fittings

We highly recommend use of the John Guest® Speedfit® range of push-in plumbing fittings in conjunction with Nova-Flo™.

See www.johnguest.co.uk for more information.

WARRANTY

Nova-Flo™ (the device) is warranted to be free of defective parts, material and construction at time of supply. The device is designed for occasional use as a preventative device and should not be used as a means of automatically setting your bath water level on a regular basis.

About Time Design Ltd (the company) and our suppliers take no responsibility for the quality of fitment of Nova-Flo™ or any loss or damage caused by defective installation. We recommend installation by a qualified professional plumber to ensure there are no leaks and the device performs according to specification. The company takes no responsibility for consequential loss under any circumstances.

In event of queries, in the first instance please contact us on 020 7793 2260

Nova-Flo
About Time Design Ltd
453 Southbank House
Black Prince Road, London SE1 7SJ

+ 44 (0) 20 7793 2260
www.nova-flo.com info@nova-flo.com

Nova-Flo™ and Flowban™ are registered trademarks of About Time Design Ltd 2009